



USER'S MANUAL

Split Wall-Mounted Air Conditioner Heat Pumps

powerful. quiet. reliable.

Foreword

Air conditioners are pieces of high value. In order to ensure your lawful rights and interests, please have the professional technicians to do the installation for you.

This Instruction Manual is the universal-purpose version for the models of split wall-mounted air conditioners manufactured by our Co. The appearance of the units that you purchase might be slightly different from the ones described in the Manual, but it does not affect your proper operations and usage.

Please read carefully the sections corresponding to the specific model you choose, and keep the Manual properly so as to facilitate your reference at later time.

Addition to the user manual:

The appliance is not intended for use by young children or infirm persons without supervision; Young children should be supervised to ensure that they do not play with the appliance.

Contents

Instructions to users	1
The name of each part and its function	3
Operation and indication sections of remote controller	6
Use of remote controller	8
Features of heating operations	9
Methods of maintenance	10
Treatment at service call	11
We hope you will know the following when using the unit	12

【Instructions to users】

Please read the "Instruction Manual" carefully prior to the use of your air conditioner so as to ensure proper operations.

Instructions for Installation

- Make sure to have the professional after-sale service persons of our company or the authorized dealers to install the units before you use.

1. The units are not to be installed at places where there might be leakage of combustible gases.



In case that the leaked gas accumulates around the units, there might occur the accident of fire hazards.

Make sure that the earth leakage-circuit breaker is installed.

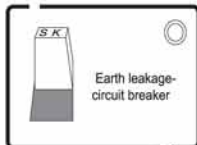

Absence of the earth leakage-circuit breaker might lead to electric shock and some other hazards.

After the connecting of the wires between the indoor unit and the outdoor unit, check whether the connecting is loose or not by pulling the wire with a little force.

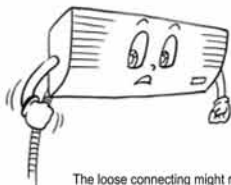

The loose connecting might result in fire hazard.

Make sure that the air conditioner is properly grounded.

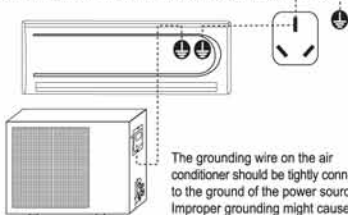

The grounding wire on the air conditioner should be tightly connected to the ground of the power source. Improper grounding might cause electric shocks or other hazards.

Instructions for Operation

Never try to stop the operation of the air conditioner by pulling out the power supply line.



Such performance might cause electric shocks or fire hazards.

Do not connect the power supply line to an intermediate connector. Use of prolonged power line is strictly forbidden. Nor is it allowed to share the same plug connector with other electric appliances.



It might cause electric shocks, overheating, fire hazards or other accidents.

Do not press, stretch, damage, heat or modify the power line.



It might cause electric shocks, overheating, fire hazards, etc. If the power line wire is damaged or needs to be replaced due to some other reasons, please make sure to have dealer or the authorized maintenance people to do the replacement.

Do not operate the switch by wet hands.



It might cause electric shocks.

Before the connector is plugged in, please make sure that there is no dust on it and that it is plugged fully in place



If there is dust on the plug or if the plug is not in place, it might cause electric shocks or fire hazards.

Never use the fuse with incorrect capacity or any other metal wires.

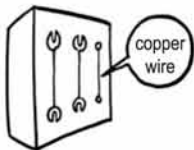

The use of metal or copper wires for fuse might cause operational failures or fire hazards.

Try to avoid the sunlight and hot air from entering the room.



During the cooling operation, curtains or window-blinds should be used to shade off the sunlight.

Do not place insecticides or paints and other flammable sprays near the air conditioner, or spray them directly at the air conditioner.



It might cause fire hazards.

Do not insert sticks or bars into the air vents.



As the fan is in high-speed operation, the insertion might lead to accidents.

Do not clean the air conditioner with water.



It might cause electric shocks.

Do not sit on the outdoor unit or place any other objects on it.



The falling down of the unit or the objects might cause human injuries and other accidents.

Try to minimize the generation of heat during the operation of cooling.



Place the heating sources out of the room.

When it is necessary to use the air conditioner and the combusting apparatuses in the same room, air ventilation has to be made from time to time.



Insufficient ventilation might lead to lack of oxygen or some other dangers.

Adjust the air direction correctly.



Properly adjust the up/down and left/right directions of the air flow so as to get the even room temperature.

Do not attach, hang or stack articles on the air conditioner.



It might lead to the falling down of the air conditioner unit, which will result in accidents or injuries.

Do not use the following substances:



Hot water (over 40°C or 104°F)
The use of hot water will deform the air conditioner or make it fade in color.
Gasoline, paint diluent, benzene and polishing agents, etc.
These substances will deform the air conditioner or cause scratches.

Do not use combusting apparatuses in the air-conditioned room.



It might lead to the incomplete combustion of these apparatuses.

Prior to the maintenance of the air conditioner, please cut off the power supply first. Never do the cleaning of the units when the fan is in high-speed operations.



Do not keep exposed to the cool air for long time.

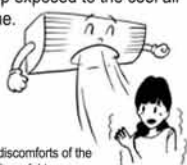

It might cause discomforts of the body, which is harmful to your health.

Check the supporting structures of the units carefully.



In case of damages, the supporting structures should be immediately repaired so as to avoid falling down of the unit, which might cause human injuries or other accidents.

Pull out the plug when the unit is not in use for long time so as to ensure safety.

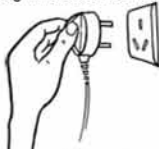

When the plug is to be pulled out, make sure that the switch of the air conditioner is turned off.

Instructions for Removal and Repair

- When removal or repair is needed, please contact the dealer or authorized maintenance & installation people.
- In case of any abnormal occurrences (smell of burning), please stop the operation at once, cut off the power supply and contact the dealer or authorized maintenance people.

【The name of each part and its function】

Because there are many models, features and appearance will vary, we only introduce the follow pattern, Others please refer to using.

Indoor Unit

Air return grid
Takes in the indoor air

Operational performance/indications

Indications of unit 1

Running indicator Timer indicator

RUN TIMER
○ ○

Setting temperature, timer time, and failure code indicator

Left/right air flow direction adjusting fin

Up/down air flow direction adjusting flap

Air outlet

Air blows out from here

Air filter

Removes dust or dirt out of the inlet air

Drain tube

Drain the water dehumidified out of the air

Indications of unit 2



TURBO operation indicator



Setting temperature, timer time and malfunction code indicator



Timer indicator



Running indicator

Receiver of remote controller signal

Outdoor Unit

Air inlet
at sides & rear surface

Air discharge vent

Refrigerant piping connection, Electric wiring cord

Unit operation section

How to open

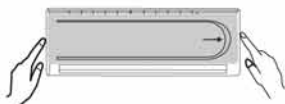

Lightly push both sides of the air inlet grid at the bottom and pull it to this side till a resistance is felt.

How to close

Push down the air inlet grid and then push both sides of air inlet grid at the bottom.

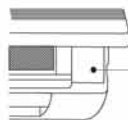

Emergency operation key

This button can be used as an emergency measure to turn on/off unit when remote controller is not available.

● Note: Do not open the grid at an angle over 60 degrees. Do not operate the units with too much force.

Indications of unit 3

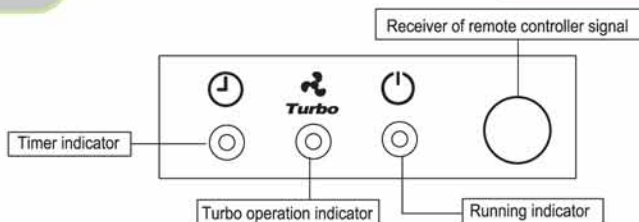

Indications of unit 4

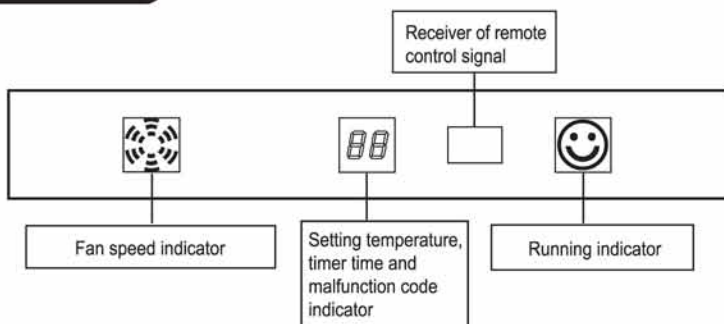

Indications of unit 5

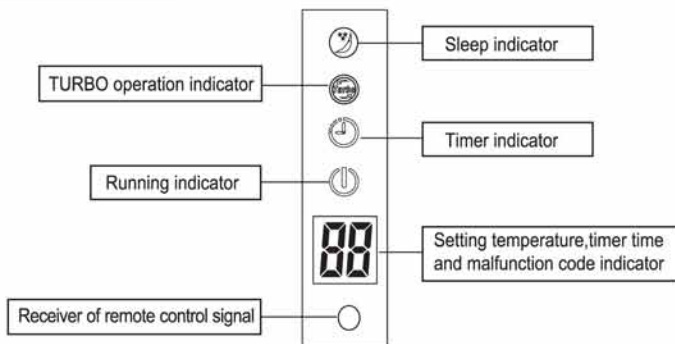

Indications of unit 6

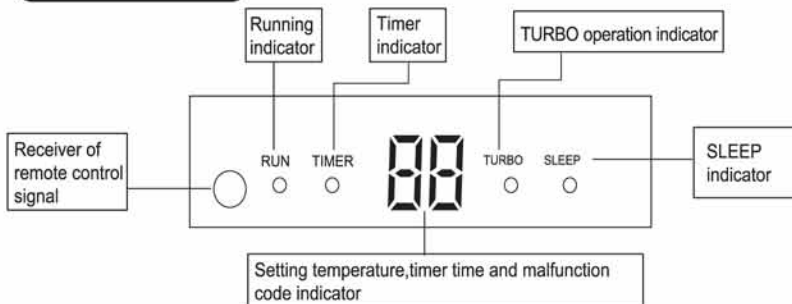

Indications of unit 7

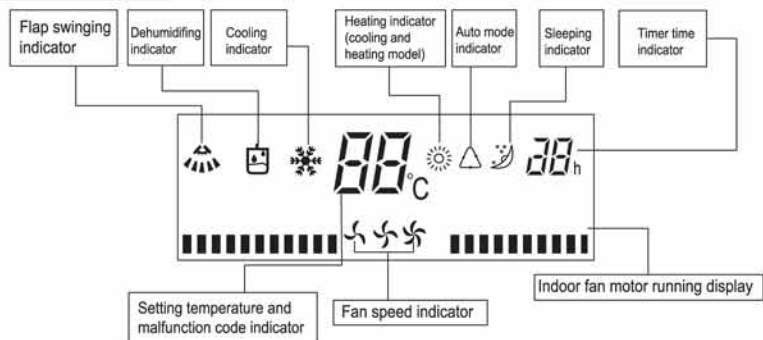

Indications of unit 8

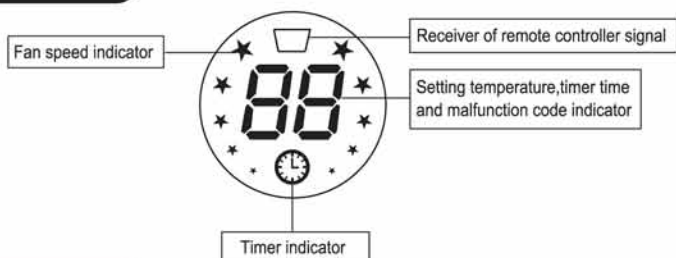

Indications of unit 9

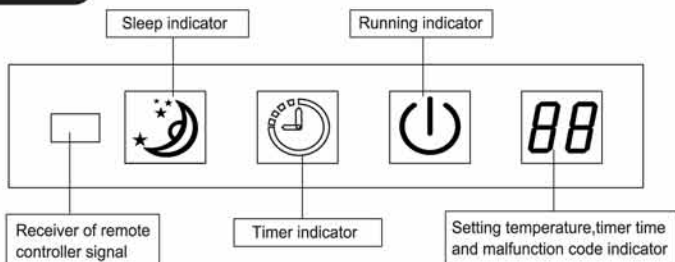

Indications of unit 10

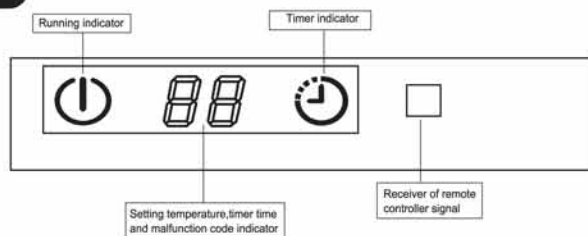

Above figure shows all indications for the purpose of the explanation but practically only the pertinent parts are indicated. The indicator may be changed, but it does not affect your operation.

[Operation and indication sections of remote controller]

Attention:

- The appearances of the following two remote controllers will vary, but the functions of the same button are same. Please check to refer the instructions for the identical remote controller of your air-conditioner.
- The remote controller 1 and remote controller 2 are the general one used for many types of air-conditioner in our company, we beg your forgiveness that we would not introduce the button or indicator which is not applicable for units you purchased. The "LAMP" and "CLEAN" button are applicable for special latest developed new models only instead of normal models. The "AIR FLOW" button is an optional function button, it just works on those models with three-dimensional air flow function.

Remote Controller 1

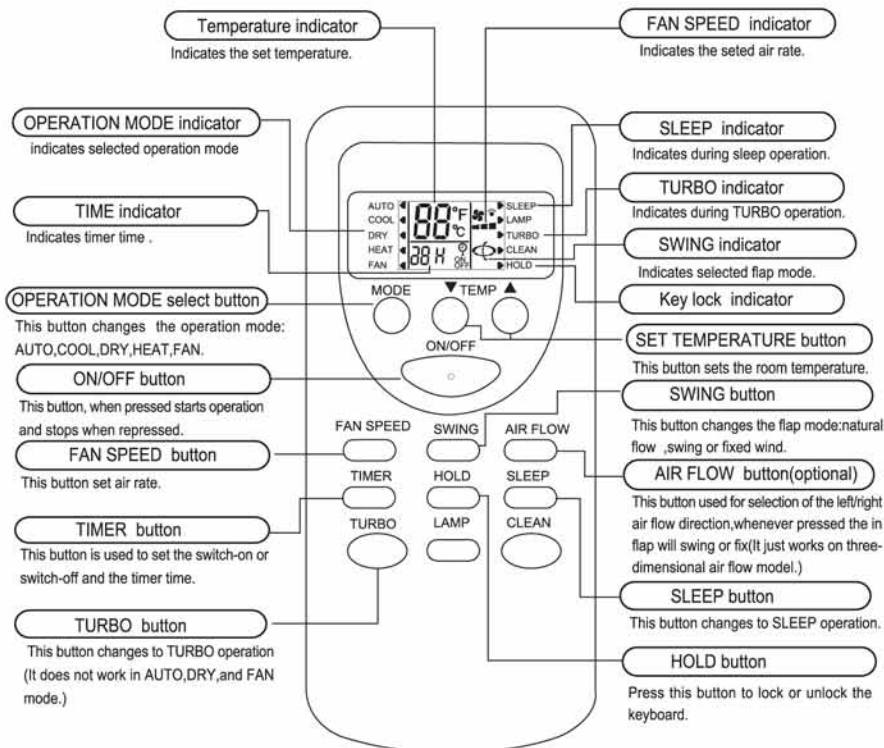

NOTE:

- Above figure shows all indications for the purpose of explanation, but practically only the pertinent parts are indicated. When air-conditioner is cooling-only model, the HEAT is for FAN.
- When TURBO operation is selected, room temperature is not controlled with operation being continually. If you feel the room temperature is too cool or too heat, please cancel the TURBO operation.

Remote Controller 2

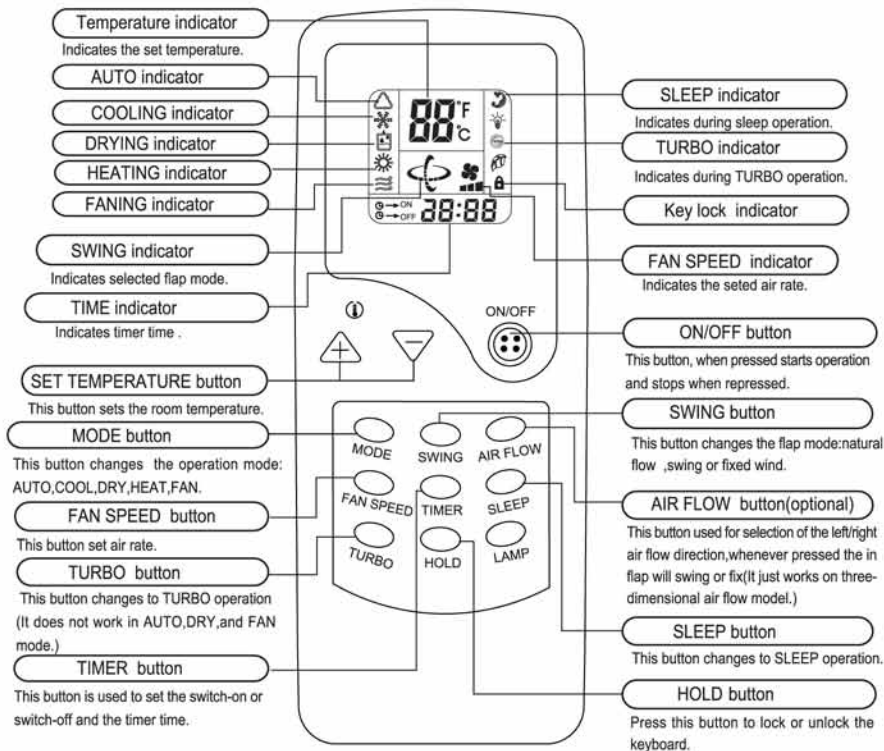

NOTE:

- Above figure shows all indications for the purpose of explanation, but practically only the pertinent parts are indicated. When air-conditioner is cooling-only model, the HEAT is for FAN.
- When TURBO operation is selected, room temperature is not controlled with operation being continually. If you feel the room temperature is too cool or too heat, please cancel the TURBO operation.

Transmission procedure

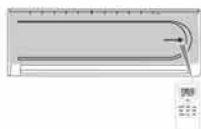

When each button on the remote controller is pressed with the remote controller pointing toward the air conditioner unit, signal is sent. When the signal is received correctly, the receiving sound is emitted from the unit.

OPERATING MACHINE IN SELECTED MODES

1. Point the remote controller at the unit, press the ON/OFF button, then press the MODE button, select the needed mode: ATUO, COOL, DRY, HEAT, or FAN.
2. Press the SET TEMPERATURE button to increase or decrease the readings until the needed temperature is displayed. The room set temperature range is from 16°C-32°C (61°F-90°F).
(It would be automatically set at 25°C (76°F) and unadjustable in AUTO and DRY mode.)
3. Press the FAN SPEED button to choose the air rate you want: Low (display indicates "▲"), Med (display indicates "▲▲"), Hi (display indicates "▲▲▲"), Auto (display "▲▲▲" indicator flashing).
(It would be automatically set at low speed and unadjustable in DRY mode.)
4. Press the SWING button to choose the up/down air flow direction you want: natural flow (display indicates "┌"), swing (display "┌" indicator flashing), fixed wind (display indicates "┌").
(It would be automatically set at fixed wind air flow direction in DRY mode.)

TURBO OPERATION

Press TURBO button during COOL or HEAT operation, the air rate can be set in HIGH. Press the TURBO button again can release the TURBO operation.

Note: during TURBO operation, the air rate can't be changed.

ADJUSTING LEFT/RIGHT AIR FLOW DIRECTION

Methods 1: Manually adjust

Adjust the direction by moving directly the left/right air flow direction adjusting fin by hand.

Caution: when adjust the direction, stop air conditioner.

Methods 2: Horizontal & vertical auto swing (three-dimensional air flow model)

Adjust the direction by remote controller. Press the AIR FLOW button, the air swinging fins will constantly make the left/right swinging or fixed direction in air delivery.



TIMER OPERATION

Set turning off time

Set the time for the unit to turn off and when it is time, the air conditioner will automatically stop operating.

1. During the operation of the air conditioner, press the TIMER button and the air conditioner will enter the timed switch-off mode.
2. Continually press the TIMER button to set the needed time for switching off the machine. The timer can make the setting in the range from 1-24 hours. Every the button is pressed, indication change is the following sequence: 1 → 2 → → 24 → cancel (no indication) → 1.
3. After the setting of the timed switch-off, the digits shown on the display screen will go down by 1 for every elapsed hour. The displayed digits indicate the remaining time prior to the timed switch-off.

Set turning on time

Set the time for the unit to turn on and when it is time, the air conditioner will automatically start operating.

1. When the air conditioner is in the standby mode, press the TIMER button and the air conditioner will enter the timed switch-on mode.
2. Continually press the TIMER button to set the needed time for switching on the machine. The timer can make the setting in the range from 1-24 hours. Every the button is pressed, indication change is the following sequence: 1 → 2 → → 24 → cancel (no indication) → 1.
3. After the setting of the timed switch-on, the digits shown on the display screen will go down by 1 for every elapsed hour. The displayed digits indicate the remaining time prior to the timed switch-on.

Releasing procedure

When the indication on display screen is 24 hour, press the TIMER button again to delete the timed mode.

SLEEP OPERATION

Use this mode to reduce operation sound when sleeping, etc.

Press the SLEEP button, the air flow sound from the indoor unit is decreased.

Press the SLEEP button again can release the mode.

NOTE:

- Use the sleep mode when you are going to bed. If this mode is used in the day, the capacity is reduced since the ambient temperature is too high. (COOL MODE).
- During the operation of cooling, the room temperature will be raised gradually by 2°C (4°F) higher than the setting after the machine begins to operate in the sleeping mode.
- During the operation of heating mode, the room temperature will be dropped gradually 5°C (9°F) lower than the setting after the machine begins to operate in the sleeping mode.

REPLACEMENT OF BATTERIES

- When the signal from the remote controller becomes weak and the indoor unit can not receive it properly; or the indications on the display screen becomes blurred, please slide the back cover and replace with two new batteries.
- The positive and negative poles must match the installation positions.
- New batteries of the same type have to be used for replacement.
- If the remote controller is not to be used for long time, take out the batteries so as to prevent the leakage of the electrolyte from damaging the controller.
- If when the remote controller is at abnormal state, you can take out the batteries on the back cover to clear off the display.



Remote Controller 1

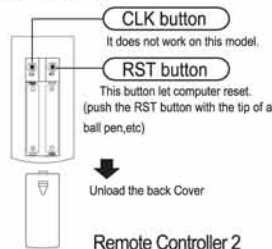

Basic principles and performances

- The machines absorb heat from the outdoor air and transfer it indoors so as to heat the room air. The heating capabilities through this principle of heat pump go up/down with the increase/decrease of the temperatures of the outdoor air.
- It only needs a fairly short time for such hot air circulation system to raise the room temperature.
- When the outdoor air temperature is very low, the system can be used together with other heating devices. But good ventilation should be maintained to ensure safety and prevent accidents.

Defrosting

When the outdoor air temperature is very low and humidity is very high, frosting will occur to the heat exchanger of the outdoor unit, which has negative impacts upon the efficiency of the heating performance. In such case, the automatic defrosting function will come into play. The heating operation will be stopped for 5-10 minutes to do the defrosting.

- The fans of both the outdoor and indoor units are stopped.
- During the defrosting, the outdoor unit might generate some steam. It is caused by fast defrosting, which is not a performance failure.
- Upon the completion of the defrosting process, the heating operation is resumed.

【Features of Heating Operations】

The air conditioner must be turned off and plug pulled out before the maintenance is to be carried out.

Before the season of operation

- 1** Check if there are any blocking materials in the intake and outlet vents of the indoor and outdoor units.

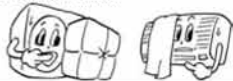

- 2** Check if the installation stand is corroded or rusty.

- 3** Check if the machine is properly grounded.

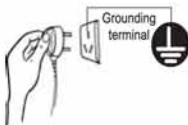

- 4** Check if the air filter is clean.

- 5** Connect to the power source.

- 6** Put batteries in the remote controller.

During the season of operation

The cleaning of the air filter screen (Standard intervals should be once every two weeks).

- 1** Remove the air filter screen from the unit.

- Gently press the two lower ends of the grid and open it.
- Gently pull up the air filter screen and take it out in the direction of your body.



- 2** Clean the air filter screen.

if the screen is very dirty, please use lukewarm water (about 30°C or 86°F) to clean it. Air it dry after the cleaning.

Note:

- Do not use boiling water to clean the screen.
- Do not bake the screen dry over a fire.
- Do not exert too much force in pulling and stretching the screen.

- 3** Install the air filter screen.

To operate the air conditioner without the air filter screen on will cause the interior of the machine dirty which might lead to poor performances or damages to the units.

Clean the air conditioner

- Use a soft and dry cloth to rub the air conditioner, or use a vacuum cleaner to clean it.
- If the air conditioner is very dirty, use a piece of cloth and soak it with neutral home-use detergent to do the cleaning.



After the season of operation

- 1** Set the temperature at 30°C or 86°F and operate in the fan status for about half a day.



To make the interior of the units dry

- 2** Stop the operation of the machine and turn off the power switch.

The air conditioner will consume about 5W of electric power after the machine is turned off. For the purpose of energy saving and safety, it is advisable to pull the plug out during the non-operational seasons.



- 3** Clean and install the air filter screen.

- 4** Clean the indoor and outdoor units.



- 5** Take the batteries out from the remote controller.

Note:

If the air filter screen is blocked by dust or dirt, the performance of cooling and heating will be affected, with the operation noise and power consumption increased. Therefore, the air filter screen should be cleaned regularly.

【Treatment at service call】

Please check the following before requesting after-sale service from your dealer .

The air conditioner does not operate at all .

Is the power plug in an outlet ?



Is the time set to "ON" position ?



Is there a power failure or a blown fuse ?



Poor cooling or heating performance .

Is the room temperature setting suitable ?



Are the air filters clean (Not clogged) ?



Are the window (s) and door (s) opened ?



Poor cooling performance .

Is direct sunlight entering the room ?



Is there a heat source in the room ?



Are there too many people in the room ?



Cases requiring immediate contact with the distributor

Pull out the power plug immediately and inform to your distributor in the following situations:

Fuse or breaker often breaks off

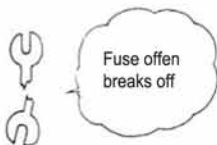

Power plug or code is excessively hot

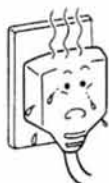

Covering of power plug or code is broken



Malfunction is observed TV , radio or other devices .



Switch dose not actuate surely







Abnormal noise is heard during operation



When faulty operation movement is observed when the RUN button is pressed , even after pulling out the power plug and restarting the operation after 3 minutes , faulty movement does not disappear .



[We hope you will know the following when using the unit]

<p>The unit can not be restarted just after shut down . (RUN lamp is illuminating)</p> 	<p>Restart is stopped for 3 minutes after shut down to protect the unit .</p>  <p>Three-minute protection timer incorporated in the microcomputer actuates automatically . Except that power is connected , this function does not actuate .</p>
<p>Air is not blown out at starting of heating operation.</p>	<p>Air blow is stopped to prevent blowing out of cold air until the indoor heat exchanger is warmed . (2 to 5 min) (HOT KEEP)</p>
<p>The unit will not stop blowing out the air immediately after shut down at COOL operation(some model).</p>	<p>Because the unit is doing mould proofing operation and indoor fan motor runs at low speed .The louver will not close down until after 30 seconds.</p>
<p>Air is not blown out for 6 to 12 min , at heating operation .</p>	<p>When outdoor temperature is low and humidity is high , the unit sometimes performs defrosting automatically . Please wait . During defrosting , water or steam are raising from the outdoor unit .</p>
<p>Air is not blown out at DRY operation .</p>	<p>Indoor fan is sometimes stopped to prevent vapor of dehumidified moisture and save energy .</p>
<p>Mist is blown out at COOL operation .</p>	<p>This phenomenon sometimes occurs when the temperature and humidity of the room are very high , but it will disappear with the lowering of the temperature and humidity .</p>
<p>Odor is sent out .</p>	<p>Air blown out during operation may smell . This is the smell of tobacco or cosmetics stucked to the unit .</p>
<p>Noise is heard cracking sound .</p> 	<p>This is caused by the refrigerant that is circulating inside the unit.</p>
<p>Noise is heard cracking sound .After a power stoppage or after disconnecting the power supply plug.</p>	<p>This is caused by heat expansion or contraction of plastics.</p>
<p>Operation can not be restarted even if the power is recovered.</p>	<p>The memory circuit of the microcomputer is cleared. Operate the remote controller again to restart the operation .</p>
<p>Remote control signals are not received .</p>	<p>Remote control signals may not be received when signal receiver on the air conditioner body is exposed to direct sunlight or strong lighting . In that case , interrupt the sunlight or darken the lighting.</p> 
<p>Moisture may form on the air outlet grilles .</p>	<p>If the unit is operated for a long period of time with the high humidity , moisture may form on the air outlet grilles and drip down .</p>

